

## D2 (Former D642), D3 (Former D640) CONTROL DAMPERS

### PRODUCT DATA



Honeywell International, Inc. certifies that the models D2, and D3 shown herein are licensed to bear the AMCA Seal. The ratings shown are based on tests and procedures performed in accordance with AMCA Publication 511 and comply with the requirements of the AMCA Certified Ratings Programs. The AMCA Certified Ratings Seal applies to air performance ratings only. March 2008.

The D2, D3 Control Dampers are ruggedly built with 3-V style blades for application as automatic control or manual balancing dampers in low to medium pressure and velocity systems. A wide range of electric or pneumatic actuators are available for these models.

The D2 series is an ultra low leakage control damper which includes blade and jamb seals. The D3 series is a general purpose damper intended for applications where low leakage performance is not necessary.

### FEATURES

#### Frame:

- Standard frames utilize heavy-duty 5 in. (12.7 cm) x 1 in. (0.25 cm) 16 ga. galvanized steel hat channel frame, designed for installation inside ductwork. Reinforced corners. Low profile head and sill on dampers less than 17 in. (43.2 cm) high.

#### Frame Options:

- Stainless steel and aluminum (14 and 12 gage galvanized steel *only*).
- Single flange (either side of frame) or double flange (both sides of frame). (See Fig. 2.)

#### Flange:

- Additional 1 1/2 in. on each side.

#### Blades:

- Standard 3-V blades are fabricated from a single thickness of 16 ga. galvanized steel incorporating three longitudinal structural V-grooves (each running the full length of the blade). (See Fig. 1.) This blade has low to medium velocity and pressure capabilities.

#### Axles:

- 1/2 in. (1.3 cm) diameter square plated steel axles positively locked to the blades eliminate slippage between blades and axles. Removable shaft extends 6 in. (15.2 cm) beyond frame. Optional stainless steel construction.

#### Bearings:

- Molded synthetic (acetal) bearings rotate in a polished extruded frame raceway. Extremely low friction and long operating life result from this advanced design. Bronze or stainless steel bearings are optional.

#### Linkage:

- Blade-to-blade linkage (for parallel or opposed blade action) is concealed within the frame.
- Linkage is engineered to accurately control each and every blade without need for adjustment. Plated steel construction ensures a long corrosion free life.

#### Seals:

- D2 Only: Flexible stainless steel compression-type jamb seals (between blade ends and side frames) and extruded vinyl blade seals (between blade edges) reduce leakage. Silicone or blade seals are optional.

#### Sizing:

- Nominal sizing results in 1/4 in. undersizing on each side. Actual sizing available as option.

### Contents

Features .....	1
Specifications .....	2
Ordering Information .....	2



## SPECIFICATIONS

### Size Limitations:

#### Pressure:

2 1/2 in. - 5 in. (622 Pa - 1245 Pa) pressure differential.

#### Velocity:

2000 fpm - 3000 fpm (10.2 m/s - 15.2 m/s).

### Size Range:

#### Minimum Size:

One Blade: 6 in. (15.2 cm) W x 6 in. (15.2 cm) H.

Two Blade: 6 in. (15.2 cm) W x 10 in. (25.4 cm) H.

#### Maximum Size:

Single Section: 48 in. (121.9 cm) W x 72 in. (182.9 cm) H.

Multiple section size unlimited.

NOTE: W and H dimensions furnished 1/4 in. (0.6 cm) undersize.

**Maximum Temperature:** 180° F (82° C).

NOTE: Temperatures exceeding 180° F (82° C) require special consideration.



M20586

Fig. 1. 3-V blade.

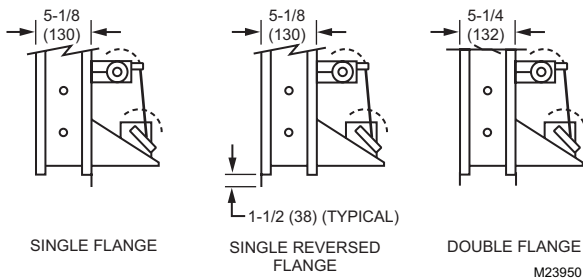

SINGLE FLANGE

SINGLE REVERSED FLANGE

DOUBLE FLANGE

M23950

Fig. 2. Flange options.

### Parallel/Opposed Blade Operation (Fig. 3)

Control dampers are offered with either parallel or opposed blades (silicone or vinyl blade seals are optional). Each style has distinguishing characteristics regarding fan performance control and change in air velocity profile:

- Parallel blade operation is preferred:
  - When the damper makes up a significant portion of the total system pressure loss.
  - When greater control is required near the top end of the volume operating range or for systems requiring two position (fully open or fully closed) operation.
  - Parallel blades should not be used upstream of critical components due to uneven airflow.
- Opposed blade operation is preferred:
  - When the damper doesn't make up a significant portion of the total system pressure loss.
  - For applications where it is necessary to maintain even distribution of air downstream from the damper.
  - For ducted outlets.
  - Opposed blade dampers must open farther to obtain the same airflow resistance as parallel blade dampers.

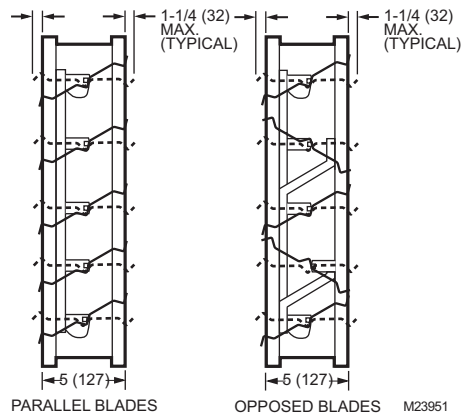

PARALLEL BLADES

OPPOSED BLADES

M23951

Fig. 3. Parallel and opposed blades.

## ORDERING INFORMATION

When purchasing replacement and modernization products from your TRADELINE® wholesaler or distributor, refer to the TRADELINE® Catalog or price sheets for complete ordering number.

If you have additional questions, need further information, or would like to comment on our products or services, please write or phone:

1. Your local Honeywell Automation and Control Products Sales Office (check white pages of your phone directory).
2. Honeywell Customer Care  
1885 Douglas Drive North  
Minneapolis, Minnesota 55422-4386

In Canada—Honeywell Limited/Honeywell Limitée, 35 Dynamic Drive, Toronto, Ontario M1V 4Z9.

International Sales and Service Offices in all principal cities of the world. Manufacturing in Australia, Canada, Finland, France, Germany, Japan, Mexico, Netherlands, Spain, Taiwan, United Kingdom, U.S.A.

### Multi-Section Assembly

Dampers larger than the maximum single section size will be made up of equal size sections which can be jackshafed together so that all sections operate together. A damper larger than the maximum single section size can only ship two sections wide and will be jackshafed together requiring one actuator drive location as shown in Fig. 4. (Max. section is 48 in. x 74 in.)

NOTE: Dampers larger than 48 in. x 74 in. (1219 mm x 1880 mm) are not intended to be structurally self-supporting. Additional horizontal bracing is recommended to support the weight of the damper and vertical bracing should be installed as required to hold against system pressure.

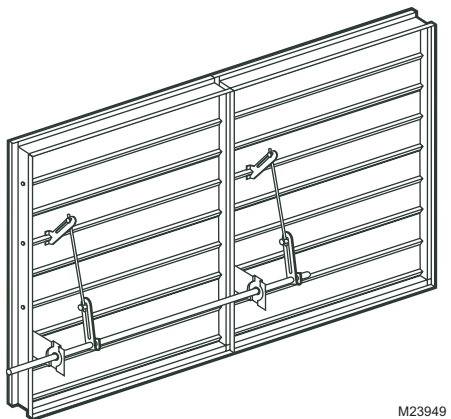

M23949

Fig. 4. Multiple section damper.

### Guide Specifications

#### Standard Volume Control Dampers

Control dampers meeting the following specifications shall be furnished and installed where shown on plans and/or as described in schedules. Dampers shall consist of: a 16 ga. galvanized steel channel frame with 5 in. (12.7 cm) depth; triple V type blades fabricated from 16 ga. galvanized steel; blades shall be completely symmetrical relative to their axle pivot point, presenting identical resistance to airflow in either direction or pressure on either side of the damper; 0.5 in. (1.3 cm) diameter plated steel axles turning in synthetic (acetal) sleeve bearings; and external (out of the airstream) blade-to-blade linkage. Damper manufacturer's printed application and performance data including pressure, velocity

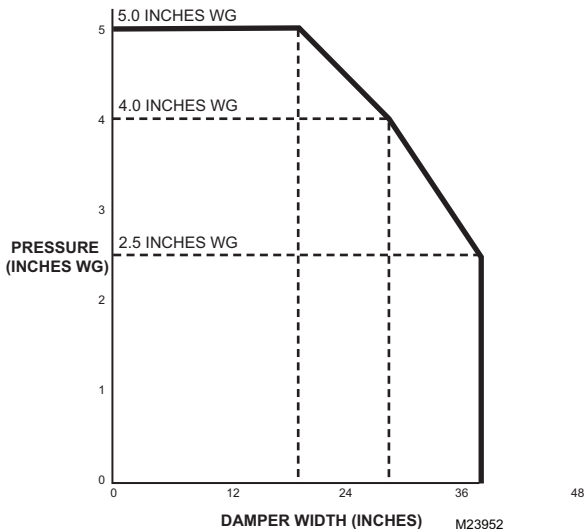

M23952

and temperature limitations shall be submitted for approval showing damper suitable for pressures to 5 in. (12.7 cm) wg, velocities to 3,000.0 ft./min. and temperatures to 180 F (82 C). Testing and ratings to be in accordance with AMCA Standard 500. Basis of design is Honeywell's model D3.

### Low-Leakage Volume Control Dampers

Control dampers meeting the following specifications shall be furnished and installed where shown on plans and/or as described in schedules. Dampers shall consist of: a 16 ga. galvanized steel channel frame with 5 in. (12.7 cm) depth; triple V type blades fabricated from 16 ga. galvanized steel; blades shall be completely symmetrical relative to their axle pivot point, presenting identical resistance to airflow in either direction or pressure on either side of the damper; 0.5 in. (1.3 cm) diameter plated steel axles turning in synthetic (acetal) sleeve bearings; and external (out of the airstream) blade-to-blade linkage. Standard blade seals shall be extruded vinyl. Standard jamb seals to be flexible stainless-steel compression type to prevent leakage between blade end and damper frame. Damper manufacturer's printed application and performance data including pressure, velocity and temperature limitations shall be submitted for approval showing damper suitable for pressures to 5 in. (12.7 cm) wg, velocities to 3,000.0 ft./min. and temperatures to 180 F (82 C). Testing and ratings to be in accordance with AMCA Standard 500. Basis of design is Honeywell's model D2.

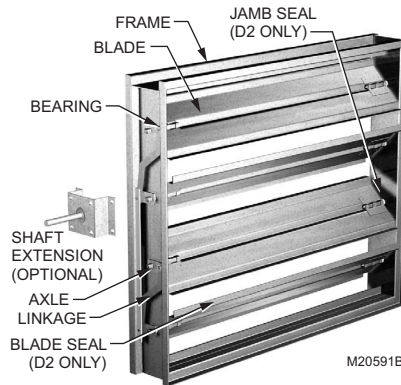

M20591B

Fig. 5. Damper components.

### Selection Criteria

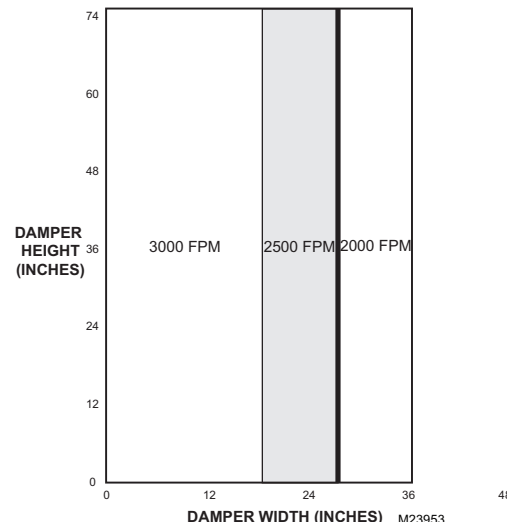

M23953

## Performance Data

**Table 1. D2, D3 Pressure and Velocity Limits.**

Damper Size in inches	Maximum System Pressure	Maximum System Velocity
12 x 12	5.0 in. wg	3000 fpm
24 x 24	5.0 in. wg	3000 fpm
36 x 36	4.0 in. wg	2500 fpm
48 x 48	2.5 in. wg	2000 fpm

NOTE: D2 and D3 will withstand higher pressures and velocities. Displayed ratings are conservative to prevent misapplication. Consult Honeywell if you have an application outside these limitations.

## Actuator Torque Multiplier

**Table 2. Actuator Torque Multiplier**

Damper	Pounds Per Square Foot
D3	5 lb-in/SF
D2	7 lb-in/SF

NOTE: Assumes 1,500 fpm.

## Leakage Data

Leakage testing was conducted in accordance with AMCA Standard 500D and is expressed as cfm/ft<sup>2</sup> of damper face area. All data has been corrected to represent standard air at a density of 0.075 lb/cubic ft. (See Fig. 6)

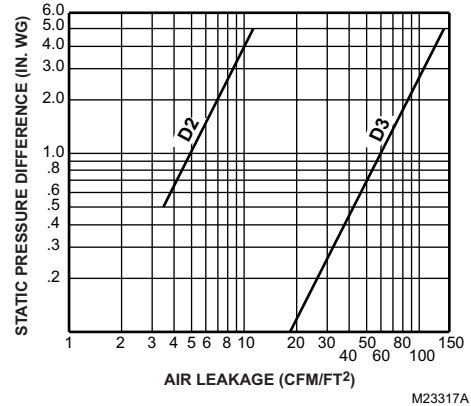

**Fig. 6. D2, D3 leakage data.**

**Table 3. Pressure Loss Coefficient (in. wg).**

	12x 12	24x 24	36x 36	12x 48	48x 12
AMCA Figure 5.3	1.52	0.67	0.43	0.7	1.2
AMCA Figure 5.2	2.25	1.19	0.67	0.91	1.7
AMCA Figure 5.5	3.64	2.28	1.89	2.15	2.84

NOTE: Data is corrected to standard air density. Average of 4,000 fpm.

Pressure loss can be determined using the following:

$$\Delta p = C_o \times (V/4005)^2$$

where  $\Delta p$  = pressure drop (in. wg)  
 $C_o$  = pressure loss coefficient  
 $V$  = face velocity (fpm)  
 5 lb-in/SF  
 7 lb-in/SF

By using this Honeywell literature, you agree that Honeywell will have no liability for any damages arising out of your use or modification to, the literature. You will defend and indemnify Honeywell, its affiliates and subsidiaries, from and against any liability, cost, or damages, including attorneys' fees, arising out of, or resulting from, any modification to the literature by you.

## Automation and Control Solutions

Honeywell International Inc.  
 1985 Douglas Drive North  
 Golden Valley, MN 55422  
 customer.honeywell.com

Honeywell Limited-Honeywell Limitée  
 35 Dynamic Drive  
 Toronto, Ontario M1V 4Z9

# Honeywell